

MAQUETAS

BOCETOS

SOFTWARE

PORTAFOLIO
Hoja 1/11

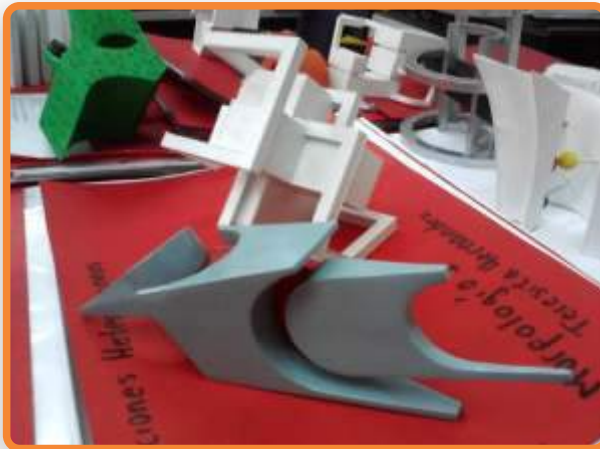
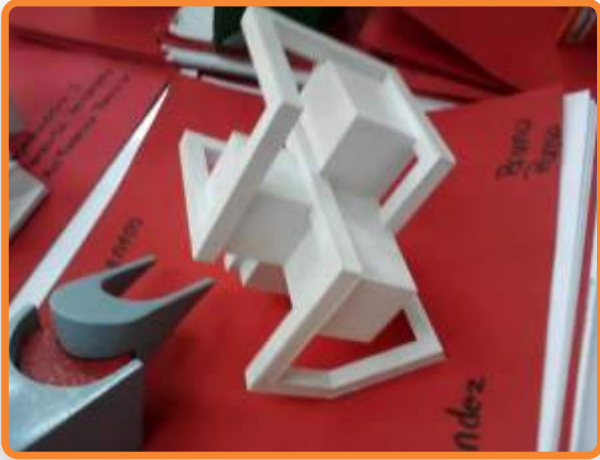

- MATERIA: Morfología I (2011)
- DESCRIPCIÓN: Propuestas morfológicas material Ps alto impacto



- MATERIA: Diseño I (2013)
- DESCRIPCIÓN: Velador articulado de Fibrofácil. (Trabajo grupal)



- MATERIA: Diseño I (2013)
- DESCRIPCIÓN: Carro de compras de cartón. (Trabajo grupal)

MAQUETAS

BOCETOS

SOFTWARE

PORTAFOLIO
Hoja 2/11

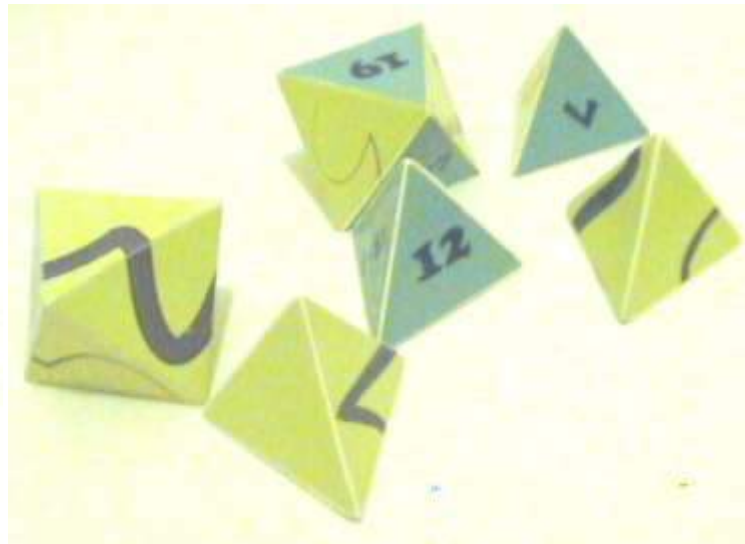
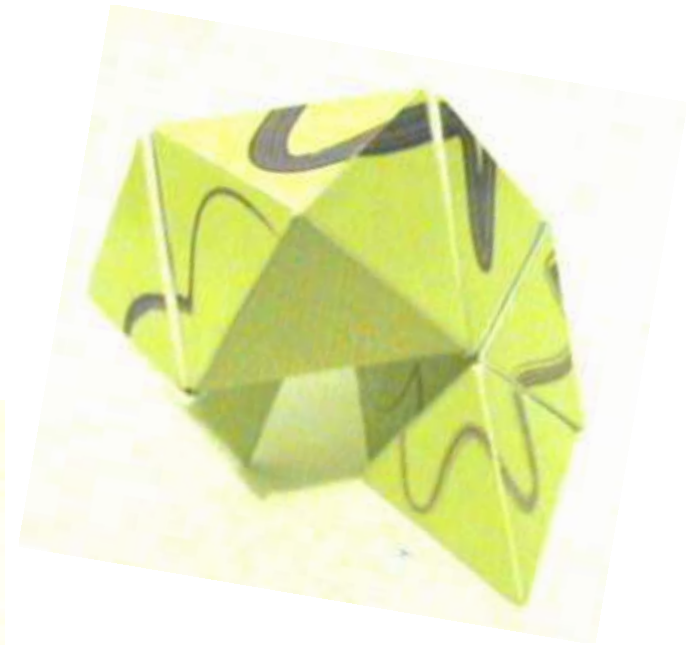
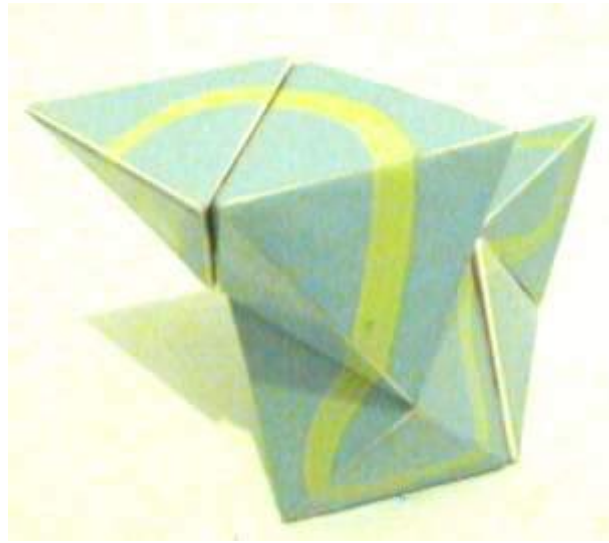
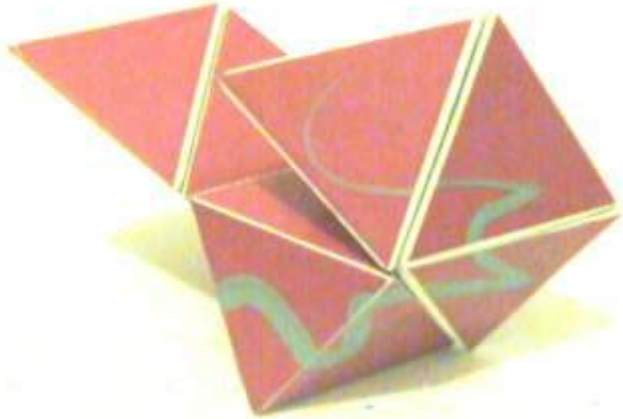

- MATERIA: Introducción al Diseño Industrial (2011)
- DESCRIPCIÓN: Jugete de sumas y restas imantado para niños.

MAQUETAS

BOCETOS

SOFTWARE

PORTAFOLIO
Hoja 3/11

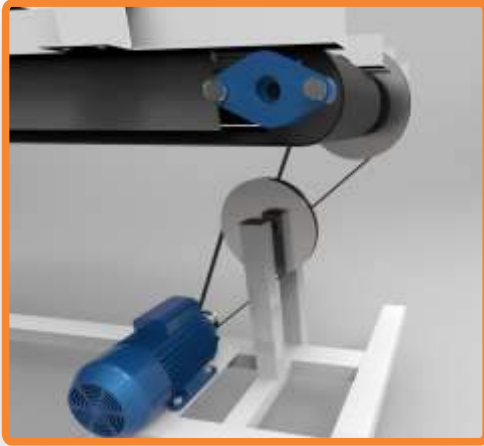

- MATERIA: Diseño Industrial III (2016)
- DESCRIPCIÓN: Maquinas de peinado e hilado de manto de seda (Trabajo grupal).
- APORTE: Cálculo de relaciones de transmisión y construcción de poleas.



MAQUETAS

BOCETOS

SOFTWARE

PORTAFOLIO
Hoja 4/11

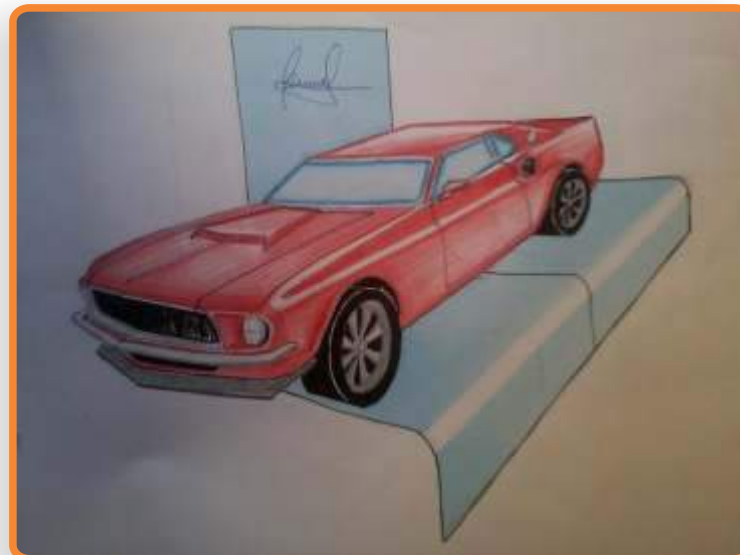

MAQUETAS

BOCETOS

SOFTWARE

PORTAFOLIO

Hoja 5/11

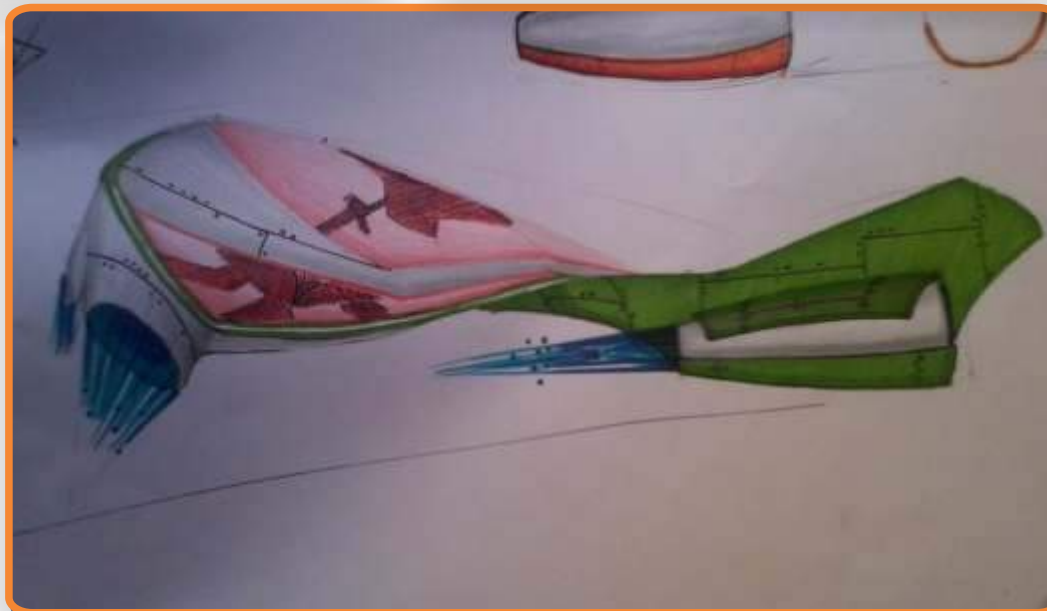
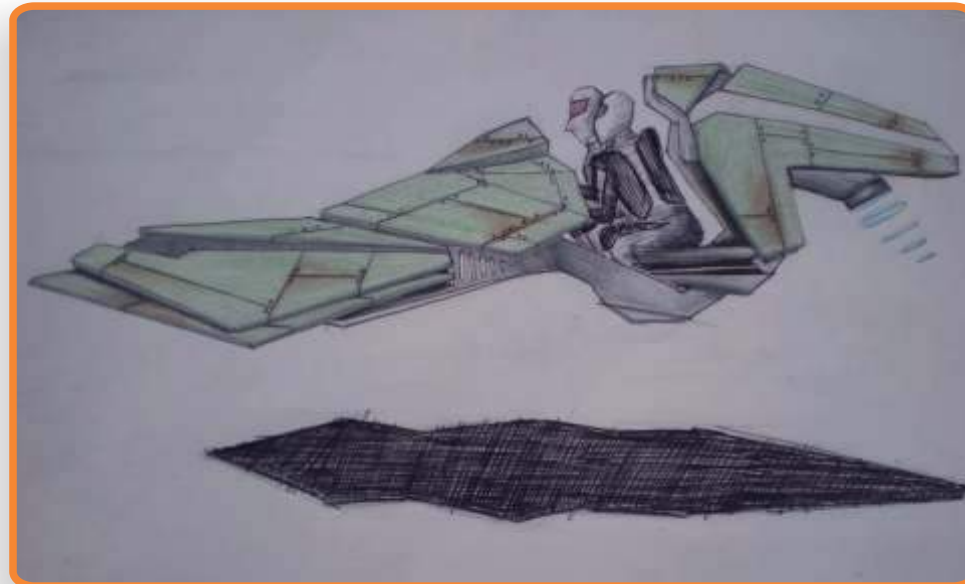

MAQUETAS

BOCETOS

SOFTWARE

PORTAFOLIO

Hoja 6/11



- DESCRIPCIÓN: Isologotipo para agrupacion de Tango (2015)
- HERRAMIENTA: Adobe Photoshop

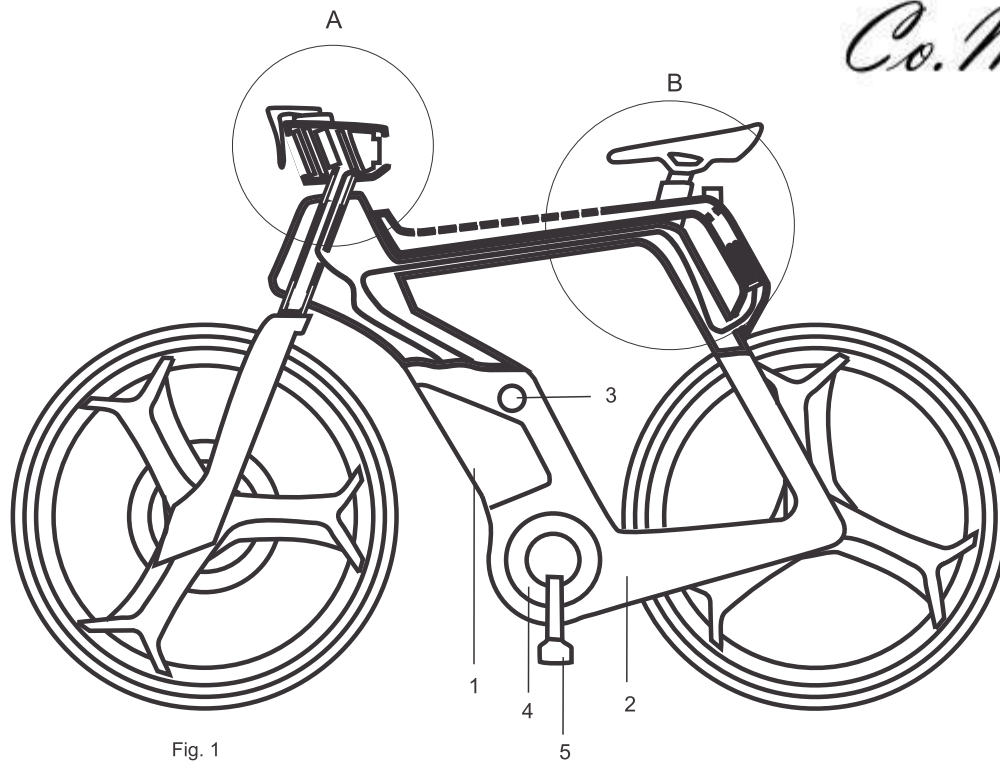

Fig. 1

- MATERIA: Legislacion (2016)
- DESCRIPCIÓN: Corte parcial de cuadro de bicicleta
- HERRAMIENTA: CorelDraw



- DESCRIPCIÓN: Folleto Torre Duomo (2017)
- HERRAMIENTA: Adobe Illustrator y Photoshop

MAQUETAS

BOCETOS

SOFTWARE

PORTAFOLIO
Hoja 7/11



- DESCRIPCIÓN: Objetos domésticos (2015)
- HERRAMIENTAS: Solidworks
Keyshot (renderizado).

MAQUETAS

BOCETOS

SOFTWARE

PORTAFOLIO
Hoja 8/11



- MATERIA: Diseño Industrial II (2015)
- DESCRIPCIÓN: Cocina móvil para acople.
- HERRAMIENTAS: Solidworks
Keyshot (renderizado).

- DESCRIPCIÓN: Camas elasticas transportables (2016)
- HERRAMIENTAS: Solidworks
Keyshot (renderizado).
Photoshop

MAQUETAS

BOCETOS

SOFTWARE

PORTAFOLIO
Hoja 9/11



- MATERIA: Equipamiento (2016)
- DESCRIPCIÓN: Expositor de maquetas y paneles para Colegio de Arquitectos.
- HERRAMIENTAS: Solidworks
Keyshot (renderizado)
Photoshop (Fotomontaje)

MAQUETAS

BOCETOS

SOFTWARE

PORTAFOLIO
Hoja 10/11



- TRABAJO FINAL de la carrera Diseño Industrial (2017)
- DESCRIPCIÓN: Camilla de Kinesiología y Fisioterapia
- HERRAMIENTAS: Solidworks
Keyshot (renderizado)

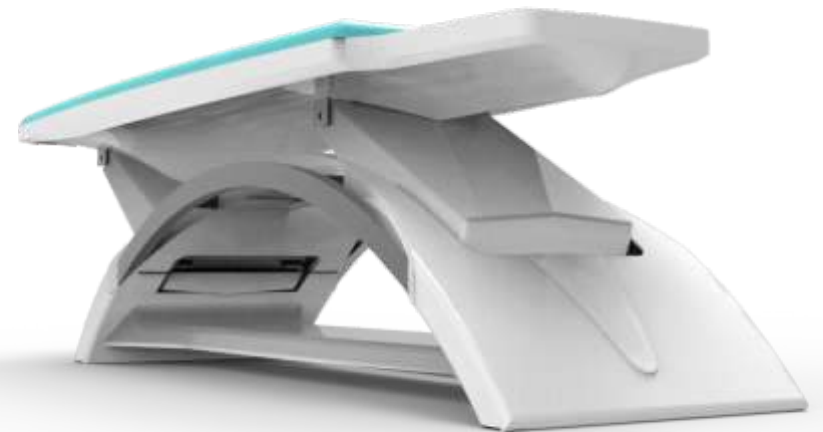
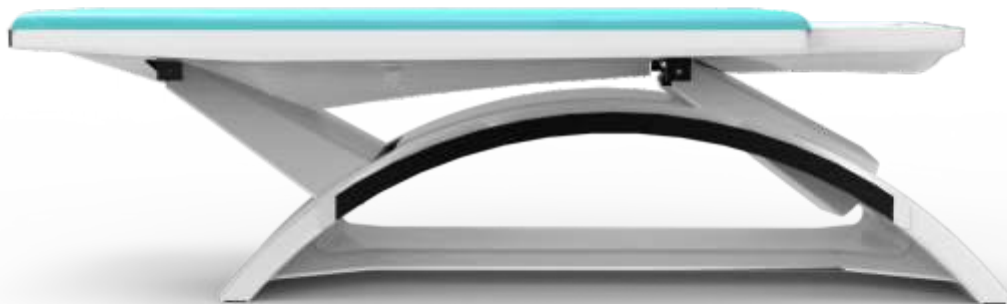

EMPRENDIMIENTO



- DESCRIPCIÓN: (2017) Lámparas de diseño para espacios interiores domésticos o comerciales



PORTAFOLIO
Hoja 11/11

